



ALBAÑILERÍA

IMPERMEABILIZACIÓN

REPARACIÓN DE CONCRETO

TERMINACIONES



Terminaciones Epóxicas en Piso de Concreto

### Primer



**NEOGARD**  
A part of HEMPEL  
**General Purpose Epoxy**  
70714+70715  
3gal. Clear Parte A-B  
**\$210.00**  
**Kit**  
Precio Regular

### Base



**NEOGARD**  
A part of HEMPEL  
**General Purpose Epoxy**  
70714-02+70715  
3gal. Gray Parte A-B  
**\$210.00**  
**Kit**  
Precio Regular

### Top Coat



**NEOGARD**  
A part of HEMPEL  
**Chemical Resistant Urethane**  
70817+70818  
1.88gal. Clear Parte A-B  
**\$279.00**  
**Kit**  
Precio Regular

TERMINACIONES

## Pisos Epóxico Alto Tráfico



Comet  
1/4  
**\$165.00**  
BOX 40 lb.

Para más opciones de colores, consulte pag 13.



**Zapatillas con Clavos**  
FDTB020620  
**\$34.00**  
Precio Regular



**Spike 20"**  
FDTB010120  
**RC20-Spike**  
**\$143.00**  
Precio Regular



**THE GREAT DANE COMPANY**  
**24" X 3/16" 16mils** **\$35.00**  
FDTB020520 FS24SE-Coating  
**24" X 1/8" 8mils** **\$35.00**  
FDTB020520  
Precio Regular

### Mezclador Doble Aspa

FDIV051620  
24094  
5"X24"

**\$17.25**  
Precio Regular

# Sella Grietas

## Techo de Concreto

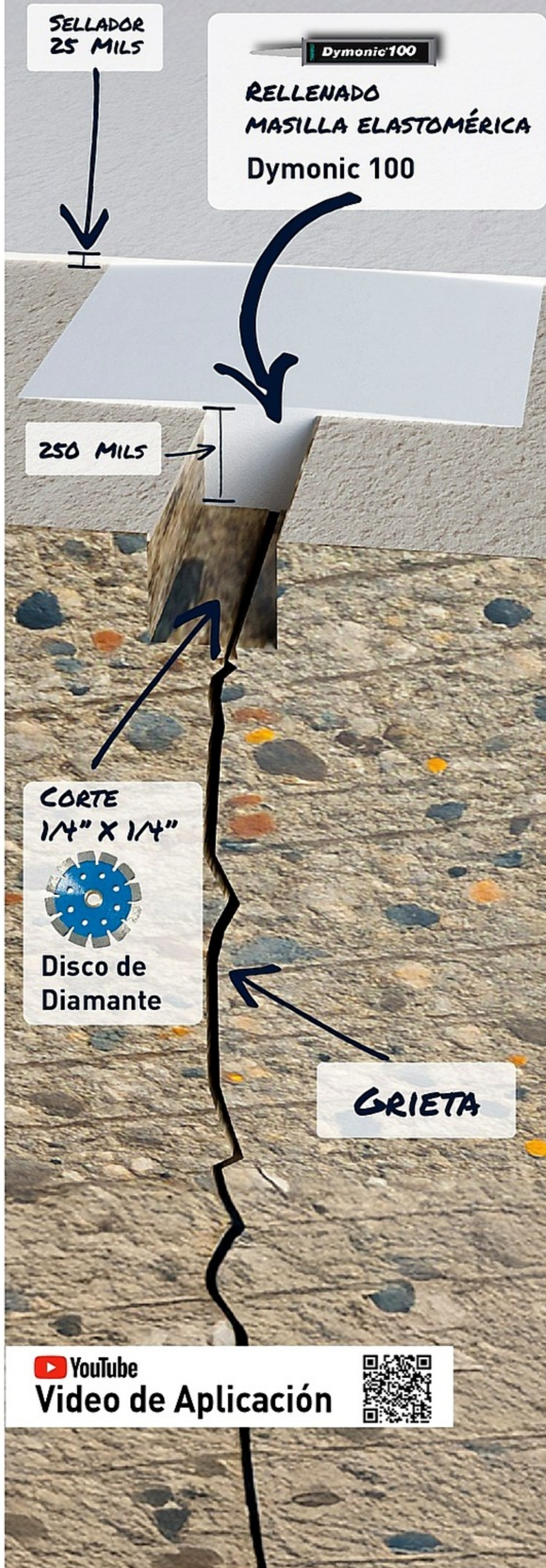

### 1. Marque

Utiliza Crayón o Tiza



Representante de Conspro  
**ERICK RIVERA**

### 2. Abra Grietas

1/4" X 1/4"



**Pro Spike**  
DISCO DE CORTE  
Para grietas en techos y paredes  
**\$35.00**  
Precio Regular  
4 1/2" x 1/4" x 1/4"



### 3. Elimine Polvo

Utiliza aspiradora o soplador



**Mini-Cepillo**  
Cerdas  
inoxidables  
**\$2.75**  
Precio Regular  
3Pcs  
FDAL010290  
SBM3

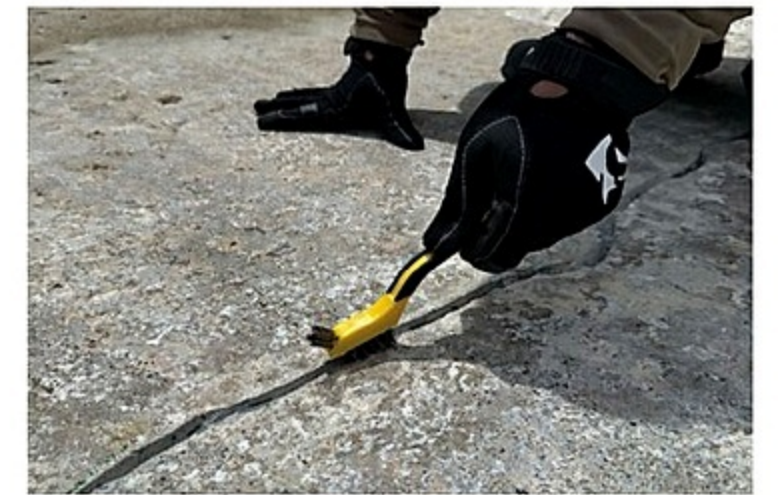

### 4. Limpie

Dentro del corte para limpieza adecuada con paño y acetona.



**Acetona**  
SOLVENTE  
-Ideal para limpieza de concreto previo a aplicación de selladores  
**\$30.00** 1gal.  
**\$11.50** Qts  
Precio Regular



### 5. Aplique el sellante

Dentro del corte de la grieta rellenando el mismo en su totalidad.



**Dymonic®100** Blanco  
SELLANTE DE GRIETAS Y JUNTAS  
Aplica en húmedo  
**\$8.00** 10oz  
**\$12.00** 20oz



**41004**  
PISTOLA MANUAL  
Para cartucho 10.3oz  
**\$23.00**  
Precio Regular



**51001**  
PISTOLA MANUAL  
Para Cartucho y Salchicha  
10oz-20oz  
**\$40.50**  
Precio Regular

### 6. Alise

Presione hacia el corte dejando una banda, de 1-2"



**Spreader**  
4"  
FDMI082320  
**\$1.00**  
Precio Regular



YouTube  
Video de Aplicación





En Techos **Pega Fuerte.**

Aditivo Látex  
Fortificador de Cemento

**\$108.00** \$30.00/gal.  
Paila 5gal. Precio Regular

**3en1**  
PEGA | ADITIVO | PRIMER



Primer



**General Repair™**  
CEMENTICIO  
Mortero de Reparación

**\$10.00**

Precio Regular

**50 lbs.**

Sistema 2K Utiliza con:  
- Sabakrete - Concryl

Escanea el QR para:  
-Video  
-Receta de mezcla  
-Calculadora  
-TDS



**Nivelación**

Dilución 3:1



**1 Saco**  
50lbs  
General Repair



1 1/8 gal  
Agua  
3/8 gal  
Sabakrete



**Parqueo**

Dilución 3:1



**1 Saco**  
50lbs  
General Repair



1 gal  
Agua  
1/3 gal  
Sabakrete



**Zabaleta**

Dilución 3:1



**1 Saco**  
50lbs  
General Repair



3/4 gal  
Agua  
1/4 gal  
Sabakrete



**Palustre de Cubo**  
7 1/2"  
FDMT041220  
18738

**\$14.00**

Precio Regular:  
\$18.50



**Palustre Rectangular**  
FDMT041320  
28869  
5"X2"

**\$17.00**

Precio Regular



**Esponja**  
7.48" X 5.12"  
FDMI081820  
SB873400

**\$4.00**

Precio Regular



**Regla Nivel**

47.2" 28395

**\$90.25**  
Precio Regular

94.7" 28399

**\$127.50**  
Precio Regular



**Micro-Topping™**  
CEMENTICIO  
Para renovación de superficie

**\$13.00**

Precio Regular

**50 lbs.**

Sistema 2K Utiliza con:  
- Sabakrete - Concryl



**Brochón**  
FDMT010120  
16520

**\$10.30**

Precio Regular



**Mezclador 30"**  
FDIV051720  
24093

**\$13.00**

Precio Regular: \$18.00



**Cepillo 24"**  
FDMI070120  
BR763

**\$12.25**

Precio Regular

1/32" | 172 Ft<sup>2</sup>

1/16" | 86 Ft<sup>2</sup>

1/8" | 43 Ft<sup>2</sup>



**1 Saco**  
50lbs  
Micro-Topping

1 gal  
Agua  
1 gal  
Sabakrete

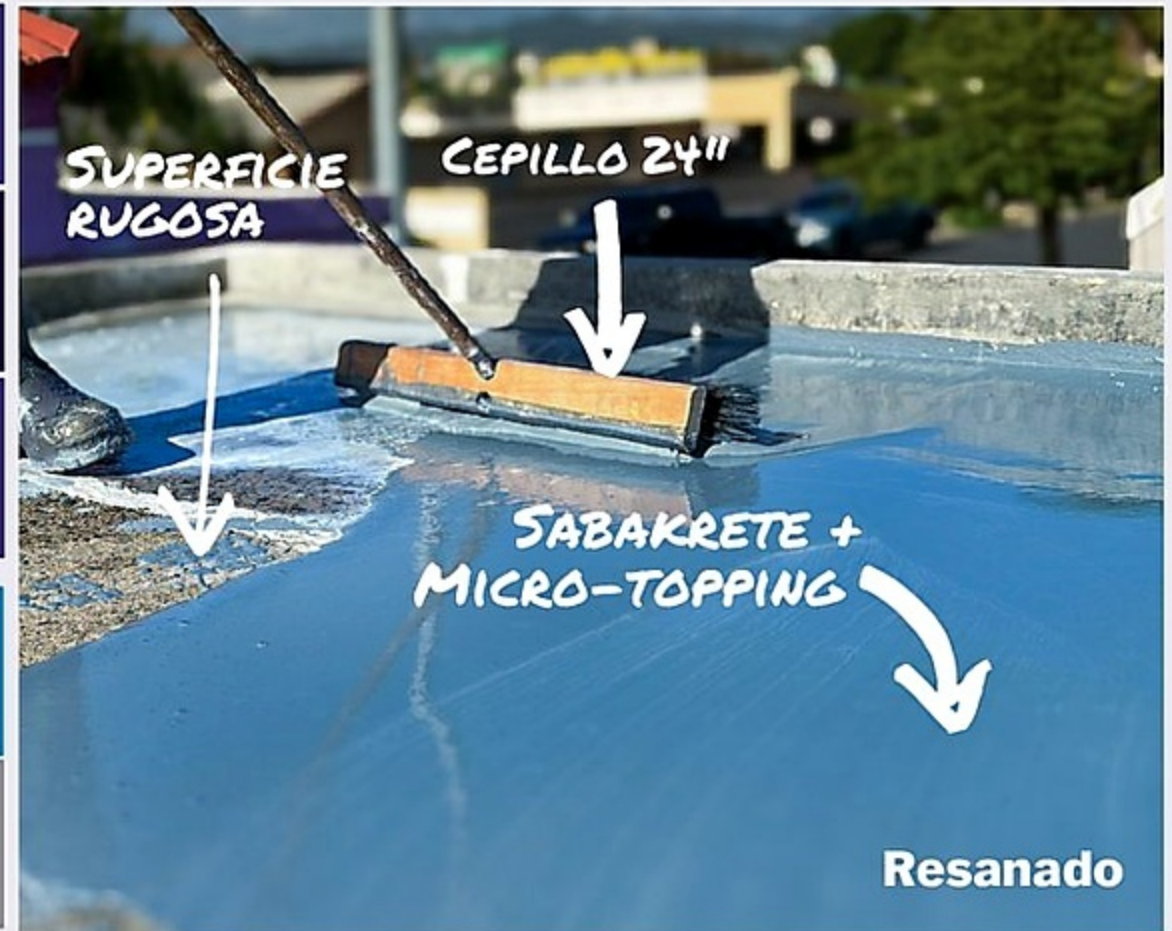

**SUPERFICIE RUGOSA**

**CEPILLO 24"**

**SABAKRETE + MICRO-TOPPING**

**Resanado**



### Top Seal™

SELLADOR ALTO DESEMPEÑO  
Tipo techo frío elastomérico  
100% Acrílico Híbrido

**7 AÑOS**  
GARANTÍA RENOVABLE DE POR VIDA

**\$175.00** Paila 5gal.

Precio Regular



YouTube Video de Aplicación



### Pro One™

SELLADOR  
Tipo Techo Frío Elastomérico  
100% Acrílico | ASTM D6083

Colores Disponibles: Blanco Gris

**5 AÑOS**  
GARANTÍA RENOVABLE DE POR VIDA

**\$125.00** Paila 5gal. | **\$32.00** 1gal.

Precio Regular



YouTube Video de Aplicación



### Pro Flex™

SELLADOR ACRÍLICO Reforzado con Fibra de Poliéster  
Tipo Techo Frío Elastomérico

**4 AÑOS**  
GARANTÍA RENOVABLE DE POR VIDA

**\$99.00** Pail. 5gal.

Precio Regular



### Elasto Seal Pro™

SELLADOR Elastomérico tipo techo-frío poli-acrílico

**\$95.00** Paila 5gal.

**\$20.50** 1gal.

Precio Regular



### Elasto Acryl

IMPRIMANTE PENETRANTE Alto en sólidos 100% acrílico transparente

**\$100.00** Paila 5gal.

**\$25.00** 1gal.

Precio Regular



### Primer Plus

IMPRIMANTE PENETRANTE 100% Acrílico Micro Polímeros rojo semitransparente

**\$75.00** Paila 5gal.

**\$13.00** 1gal.

Precio Regular

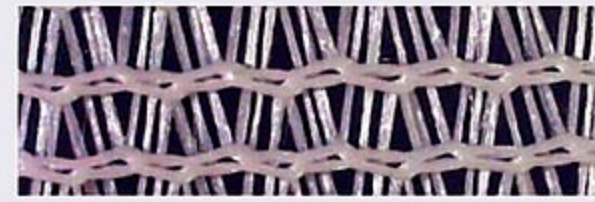

**M-1 Mesh Fabric** 300' X 42"  
Malla de refuerzo para techos  
**\$245.00**  
Precio Regular

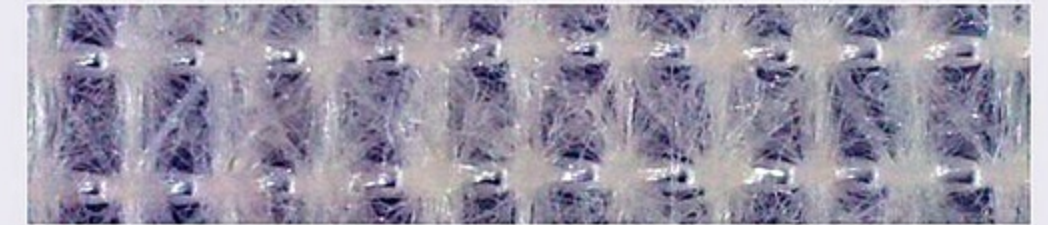

**T-272 Roofing Polyester** 300' X 6" | 324' X 40"  
Densidad 3 oz  
**\$45.00** | **\$160.00**  
Malla de refuerzo para techos  
Precio Regular



### Primer



**Urethane Primer**  
7797+7798  
3gal. Clear Parte A-B

**\$159.00**

Precio Regular

Kit



### Top Coat Techos



**NEOGARD**  
Aliphatic Urethane Roof Coating  
7490  
White

**\$394.00**

Precio Regular 5gal.



FLAKES



**NEOGARD**  
Aliphatic Urethane Traffic Coating  
7470-002 7470-011  
Gray Light Gray

**\$329.00**

Precio Regular

5gal.



**NEOGARD**  
Aromatic Urethane Traffic Coating  
7430  
Gray

**\$272.00**

Precio Regular

5gal.

### Base Coat



**Aromatic Urethane Traffic Coating**  
70410  
Gray

**\$195.00**

Precio Regular 5gal.



**Arena Sílica** 20/30  
Secado en Horno  
**\$20.00**  
Precio Regular 50 lbs



**GARANTÍA RENOVABLE DE POR VIDA**

Costos de Activación de Garantía

**ProFlex™ \$75.00 | ProOne™ \$100.00 | TopSeal \$130.00 | ProSil® \$250.00**

\*Área de techo mayor a 3,000 pies cuadrados: Se cobrará \$0.11 por pie cuadrado para activar la garantía.



Válido desde el 1 de junio de 2026 hasta 30 de junio de 2026  
\*Disponibilidad varía por tienda. Artículos fuera de inventario aplica pedido especial.

(787) 653-4900

conspro.com

4

Accede a todos los productos de:  
**Impermeabilización**



**Pro-Sil® HS Top Coat**  
SELLADOR Elastomérico  
Efecto Tipo Techo Frío Más Tiempo  
100% Silicona High Solids Blanco Duradero

**10 AÑOS**  
GARANTÍA REMOVIBLE DE POR VIDA

Especial **\$260.00** Paila 5gal.  
Precio Regular: \$285.00

**\$65.00** 1gal.  
Precio Regular

**Primer**

**Epoxy Primer W/B**

7780/7781  
Primer apto para aplicarse sobre concreto, metal, rollos asfálticos y elastoméricos previo a la aplicación de recubrimientos de alto desempeño.



**\$285.00**  
Precio Regular  
**5gal kit**



**SIL™ HS TOP Coat**  
SELLADOR 100% SILICÓN  
Alto en sólidos elastomérico  
Tecnología tipo techo frío

**10 AÑOS**  
GARANTÍA REMOVIBLE DE POR VIDA

Especial **\$220.00** Paila 4.75gal.  
Precio Regular: \$235.00



**BULL-BOND.**

**SIL MASTIC**  
SELLANTE DE JUNTAS DE SILICÓN ALTO EN SÓLIDOS

Blanco

20.3oz

**\$11.00**

Precio Regular



**51001**  
PISTOLA MANUAL  
Para Cartucho y Salchicha

**\$40.50**  
Precio Regular

10oz-20oz

**Mota Microfiber Roller Cover**



All Paints and Stains, Low VOC coatings.

**9" X 3/4" \$6.00**

**9" X 1" \$6.25**  
Precio Regular



**KIT**  
AUTO-NIVELANTE  
Techos y Pisos



**Pega Fuerte.**

**\$41.00** Paila.  
**KIT**  
Precio Regular



**Llana**  
FDMT044920  
11226  
**18" X 5"**  
**\$28.75**  
Precio Regular



**Brocha 1550**  
For Epoxies, Resins,  
Marine Paints,  
Solvents and Adhesiv

**3" \$2.00**

**4" \$3.50**

Precio Regular



**Mezclador 24"**  
FDMI081320

**\$9.00**

Precio Regular  
SD2090B



Válido desde el 1 de junio de 2026 hasta 30 de junio de 2026  
\*Disponibilidad varía por tienda. Artículos fuera de inventario aplica pedido especial.

(787) 653-4900

conspro.com

5

Accede a todos los productos de:  
**Impermeabilización**



**BULL-BOND.**



**Duroseal-Membrana**

Sellador y barrera de vapor a base de látex de goma.

Sellador y membrana previo a la aplicación de:  
- Losas - tejas- toppings

**\$110.00** Paila  
**5gal.**

**\$26.00** 1gal.

Precio Regular



Aplicaciones:

Losas

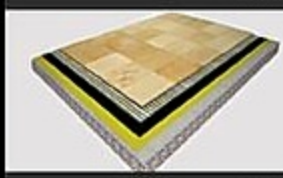

Tejas



TOPPINGs



**Vulkem® 45 SSL**

SELLANTE DE JUNTAS

Gris

**30oz \$19.75**  
Precio Regular



**Vulkem®116™**  
SELLANTE DE GRIETAS Y JUNTAS



Blanco

Gris

10oz **\$6.00**

**\$6.00**

20oz Salchicha **\$7.50**

10oz

Precio Regular

Precio Regular: \$10.00



**Dymonic® FC**

SELLANTE DE GRIETAS Y JUNTAS

Secado rápido

Blanco

10oz **\$7.00**

20oz **\$11.00**

Salchicha  
Precio Regular



**Masilla de Uretano**



**Urethane Roofing Mastic**

475JB Blanco

**\$285.00**

**3gal.**

Precio Regular



41002

PISTOLA MANUAL

Jumbo

Para cartucho cuarto de galón

**\$25.75**

Precio Regular

30oz



41001  
PISTOLA MANUAL  
Para cartucho

**\$10.50**

Precio Regular

10.3oz



**Tremproof 250**

**\$205.00**

Precio Regular

5gal.

Membrana de poliuretano para impermeabilización, de curado rápido. Diseñado para muros con relleno posterior, losas, jardineras y condiciones sumergidas.



**BULL-BOND.**

**Water Stop**

CEMENTO HIDRÁULICO  
Fraguado rápido

**\$38.00** Paila  
**5gal.**

**\$10.00** 1gal.

Precio Regular



**Aquafin 1K**

Revestimiento Cementicio, protector e impermeabilizante  
- Ideal para Cisternas  
- Certificación NSF/ANSI para agua potable



**50lb.**

Blanco

**\$50.00**

Gris

**\$48.00**



**AQUAFIN 1K**

Cisterna Impermeabilizada para agua potable



Representante de Conspro  
**GUSTAVO J. DELUCCA**



**Prime Flex 900 XLV**

Resina de baja viscosidad e hidrofílica que reacciona con el agua se inyecta para sellar uniones y grietas con fugas

**\$656.00**

Precio Regular



Paila 5 gal



**5/8" Mechanical packers #625**

Puertos de inyección de alta presión son ideales para inyección de epoxi, acrilato y poliuretano. Soportar hasta 3,000 psi

**\$385.00** Precio Regular

100pc-Box



Representante de Conspro  
**FERMIN FONTANEZ**



Válido desde el 1 de junio de 2026 hasta 30 de junio de 2026  
\*Disponibilidad varía por tienda. Artículos fuera de inventario aplica pedido especial.

**(787) 653-4900**

**conspro.com**

**6**

Accede a todos los productos de:  
**Reparación de Concreto**



**\$97.00** Paila 5gal.  
**\$25.00** 1gal. Precio Regular

Resistente a rayos UV

**3en1**

Aditivo Latex  
Pegamento  
Concreto Sumergido  
Imprimante para  
Techo de Concreto



Video de Aplicación

Representante de Conspro  
**FERMIN FONTÁNEZ**



Video de Aplicación

Representante de Conspro  
**GUSTAVO J. DELUCCA**



Representante de Conspro  
**EDISON RIVERA**



**Micro-Topping™**  
CEMENTICIO  
Para renovación de superficie  
**\$13.00** Precio Regular  
**50lbs.**



**Self-Leveling**  
CEMENTICIO  
Auto-nivelante - techo - piso  
**\$15.50** Precio Regular  
**40lbs.**

**Empañetado Pared**



Agua ¾ gal



Concryl ½ gal

**Resanado Piso** Dilución 1:2



Agua ¼-½ gal



Concryl 1-1¼ gal

**Nivelación** Dilución 1:1



Agua ½ gal



Concryl ½ gal



**Rastrillo  
Calibrador**  
FDMT041020  
16047  
**\$56.00**  
Precio Regular



**Cepillo**  
24"  
FDMT030320  
27397  
**\$23.50**  
Precio Regular



**Spike + Gancho**  
9"  
FDTB010720  
RC9-Spike  
**\$95.00**  
Precio Regular



**Mortar  
Smooth Finish**  
**\$14.25**  
Precio Regular  
**50lbs.**



**Tilt Finish**  
Compuesto de alisado y acabado  
para superficies de concreto. Es  
ideal para producir un acabado  
liso sobre superficies de concreto  
antes de aplicar pintura o  
revestimientos.  
**\$18.00** Especial  
Precio Regular:  
\$19.99  
**20 lbs.**



**Fiberglass Mesh**  
Refuerzo de fibra de vidrio  
para empañetado  
**38" x 150'**  
**\$110.00**  
Precio Regular  
Roll



**Mapecem®  
Quickpatch**  
Cemento de  
Reparación,  
de Alto Rendimiento  
y Fraguado rápido  
**\$41.00** Precio Regular  
**50 lbs.**



**Eco Prim Grip**  
Proporciona una superficie  
rugosa ideal para morteros  
modificados con polímeros,  
asegurando una excelente  
unión sobre sustratos lisos  
**\$140.00**  
Precio Regular  
**3.5gal.**



**Planigrout  
755**  
Grout a  
Alta-Resistencia  
No contrae  
Ideal para anclaje  
28 días  
13,000psi  
**\$20.00**  
Precio Regular  
**50lbs.**



**Easy Mix  
Concrete  
con fibra**  
**\$7.50**  
Precio Regular  
**5000 PSI  
50lbs.**

# Reparación de Concreto

# Corrosión Plafones

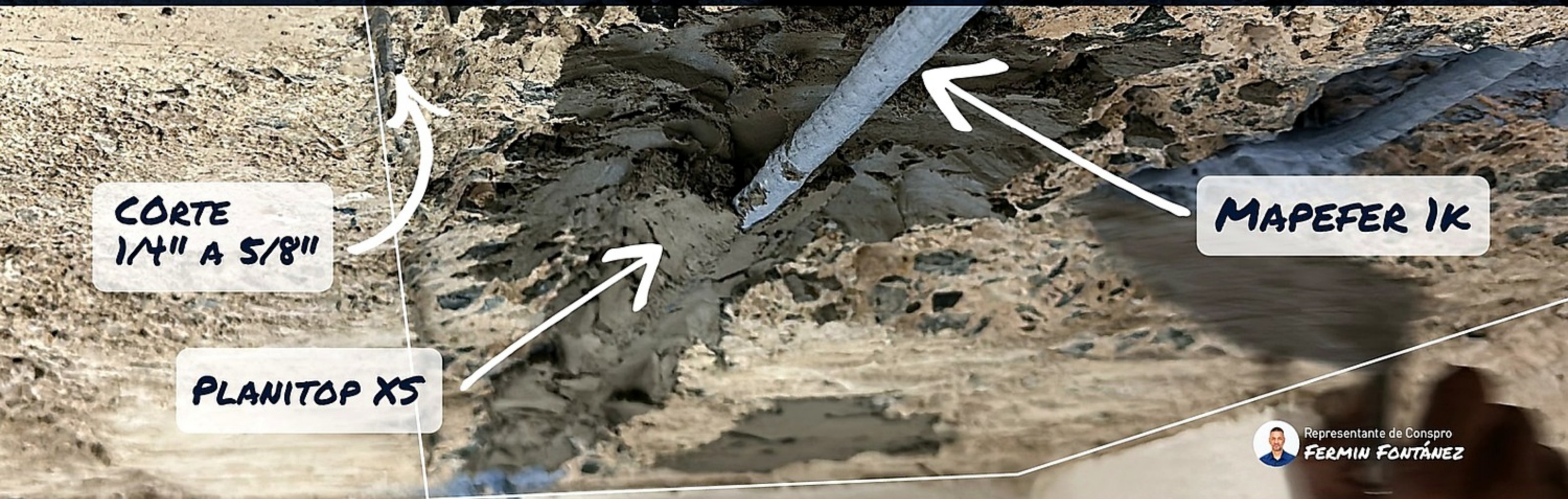

Representante de Conspro  
**FERMIN FONTÁNEZ**

**1**



4 1/2" x 0.07"

Premium Diamond

37052

DISCO DE CORTE

Diseñadas para cortar materiales duros, granito, piedra natural y concreto duro.

**\$39.50**

Precio Regular



**2**



**3**



7pc. Wire Brush Kit

39084

Juego Profesional de 7 Piezas de Cepillos/Ruedas de Alambre.

**\$27.00**

Precio Regular



**4**



Protectosil CIT

Líquido Transparente Penetrante Anti-Corrosivo Ideal para la protección de varillas de acero en estructuras de concreto.

Especial **\$485.00** Precio Regular: \$520.00

Pail. 5gal.



**5**



Mapefer 1k  
TRATAMIENTO ANTICORROSIVO para varillas

**\$28.00**

Precio Regular

10 lbs.

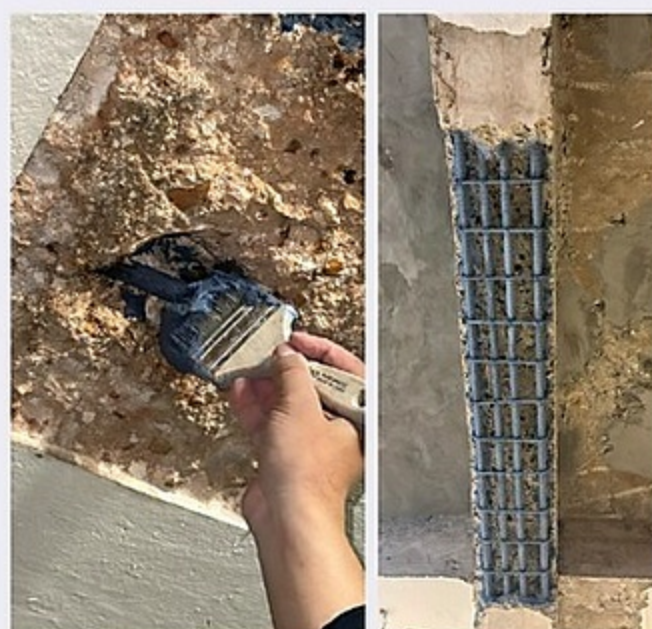

**6**



Planitop XS

MORTERO DE REPARACIÓN Aplicaciones verticales y plafones, un solo componente fraguado rápido

**\$37.00**

Precio Regular

50 lbs.



Accede a todos los productos de:  
**Reparación de Concreto**



**Surepoxy 117**  
Adhesivo epóxico formulado para instalación de varillas (dowel bars).  
**\$37.00**  
Precio Regular



**Speed Bond #1**  
Epóxico de fraguado rápido y fuerte para anclajes en concreto.  
**\$78.00**  
Precio Regular



**Prime Bond 3900**  
Adhesivo epóxico de alta resistencia, para unir concreto nuevo con concreto existente.  
**\$68.00**  
Precio Regular



**Corrosion**  
Mezcla de Reparación Inhibidor de Corrosión 4000 PSI  
**\$19.75**  
Precio Regular 50lbs

**Inyecciones Baja Presión**



**Prime Rez 1000**  
Resina epoxi de dos componentes, baja viscosidad, alta resistencia y alto módulo diseñada para inyectarse en grietas de hormigón.  
**\$57.00**  
Precio Regular 16.5oz Doble Cartucho



**Socket Mount Ports**  
Para agujeros de 1/2". Solo baja presión. Se utiliza para la inyección de morteros químicos o resinas epoxi.  
**1/2" \$68.00** Precio Regular 100pc-Box

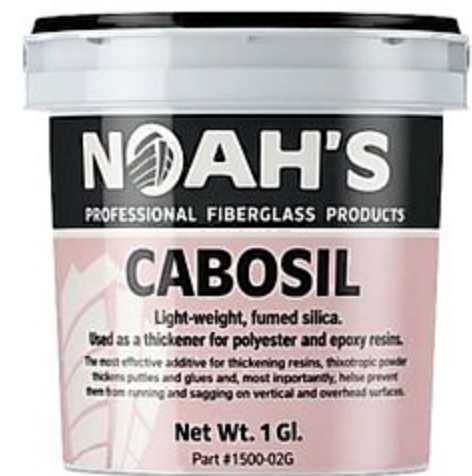

**Cabosil**  
FDFR010220  
Mejora la consistencia del epoxy, dándole más cuerpo y control para aplicaciones verticales y de relleno.  
**\$21.00** 1gal.



**M300X**  
PISTOLA MANUAL Aplicador de epoxy  
**\$89.00**  
Precio Regular Doble Cartucho 300ml. Mix Ajustable



**Caps for plastic port**  
Requerido para usar con #653, #655 y #660. Se utiliza para cerrar el puerto después de la inyección.  
**1/4" \$18.00** Precio Regular 100pc-Box

**Refuerzo Estructural | Fibra de Carbón**

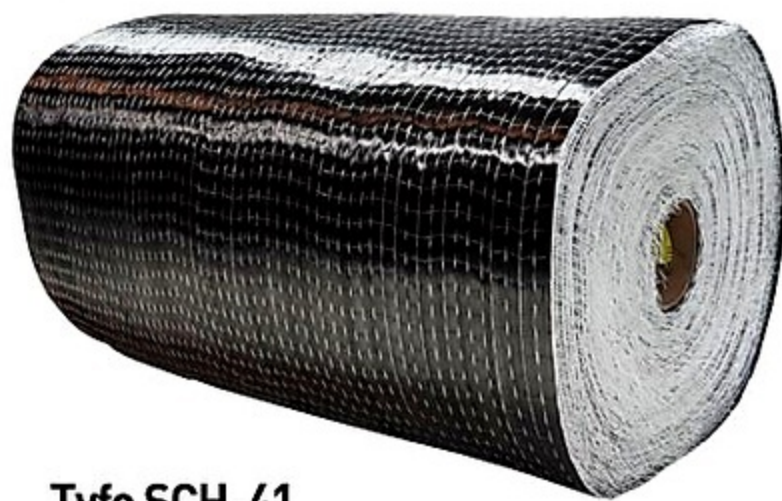

**Tyfo SCH-41**  
Composite Carbon Fiber  
Tejido de refuerzo estructural de Fibra de Carbón. Ideal para:  
- Vigas cortas  
- Paredes de carga  
**\$3,260.00**  
Precio Regular 24inX300ft Roll



**Tyfo S Epoxy Component B**  
**\$220.00**  
Precio Regular 1.2gal.



**Tyfo S Epoxy Component A**  
**\$340.00**  
Precio Regular 2.8gal.



Representante de Conspro  
**GUSTAVO J. DELUCCA**

Representante de Conspro  
**GUSTAVO J. DELUCCA**



NEW! YouTube  
Text Gold +  
Corner Bead Empaquetado

Accede a todos los productos de:  
**Albañilería (Empaquetado y Bloques)**



**Bonding Agent**  
Pega para empaquetado  
**\$72.00** Paila 5gal.  
**\$18.50** 1gal.  
Precio Regular

**Concrete Corner Beads**  
FDCD010130



Esquinero para paredes de bloques de concreto; para uso interior y exterior  
Made in USA  
**2 1/2" X 2 1/2" X 10'** BOX 50 **\$155.00**  
Precio Regular

Casing Bead

**BULL-BOND.**

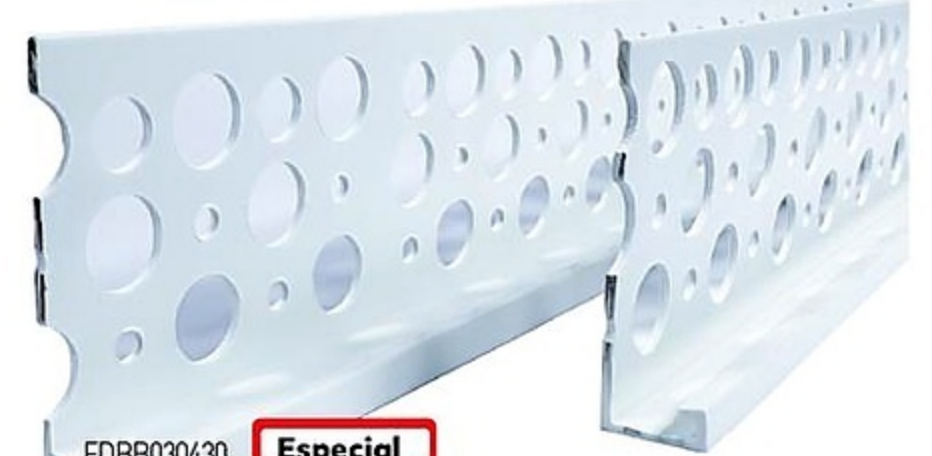

FDBB030430  
**3/4" X 10'** c/u **\$1.87**  
BOX 75 **\$140.00**  
Precio Regular c/u: \$3.60, Box 75: \$195.00

Perfil de terminación ideal para bordes limpios y definidos

**Durowall Truss**

**4"** \$120.00 BOX 50  
**6"** \$120.00 BOX 50  
Precio Regular



**BULL-BOND.**



**Enviro Mold**

Agente desmoldante a base de agua, para moldes/encofrados de madera

**\$211.00** Drum 55gal.  
**\$28.00** Paila 5gal.  
Precio Regular



**Gancho**  
4in FDMI101020

**\$2.25**  
Precio Regular



**MOTA**  
4 in X 1/4 in FDMI100720

**\$1.80**  
Precio Regular



**Polyethylene 6mils**  
Rollo plástico polietileno  
**20'X100"**  
**\$110.00**  
Precio Regular

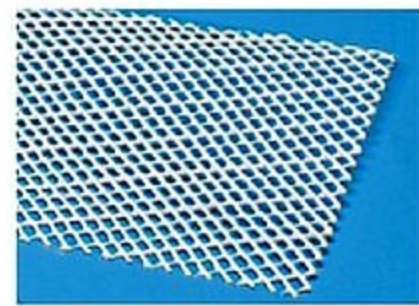

**Plastic Lath**

Proporciona unión mecánica al mortero de cemento.

Anclado directamente al hormigón o CMU

**6" x 96"**  
**\$250.00**  
Precio Regular  
BOX: 50



Plastic Lath



**ANCHOR SLOT**  
**6 ft Steel**  
(Arrimos)

**\$85.00** BOX: 20  
Precio Regular



**DOVETAIL ANCHOR**  
(Cola de Pato) **3-1/2" x 1"**

BOX 800 **\$400.00**  
Precio Regular



**Piedra de Lijar Grit 20**  
FDMT045220 16194

**\$17.00**  
Precio Regular: \$19.00



**Regla H**

**4' x 4.5"** \$55.00  
**6' x 4.5"** \$70.00  
**8' x 4.5"** **\$71.00** Precio Regular: \$91.25



**Llana**  
FDMT045020 13838  
**13"X5"**  
**\$18.50**  
Precio Regular

**Flota**  
FDMI081520 TT.1030  
**10"X4"** **\$5.00**  
Precio Regular



**MOTA Heavy Texture**  
FDLI061120 RC119

**9"X 3/8"**

**\$5.50**  
Precio Regular: \$7.25



**Flota**  
FDMT041720 14419  
**12"X5"**  
**\$15.00**  
Precio Regular



# Tex-Gold PEGA



YouTube  
Video de Aplicación



LLANA

EMPAÑETADO



## TEX-GOLD

Pega para empañetado

**\$90.00** Paila  
5gal.

**\$21.00** 1gal.  
Precio Regular



### Anti Crack

Aditivo suavizador para mezclas de empañetado

**\$90.00** Paila  
5gal.

**\$20.00** 1gal.

Precio Regular



### Contact Cement Corner Beads

Agente adhesivo de contacto rojo a base de cloropreno

**\$119.00** Paila  
5gal.

**\$30.50** 1gal.

Precio Regular

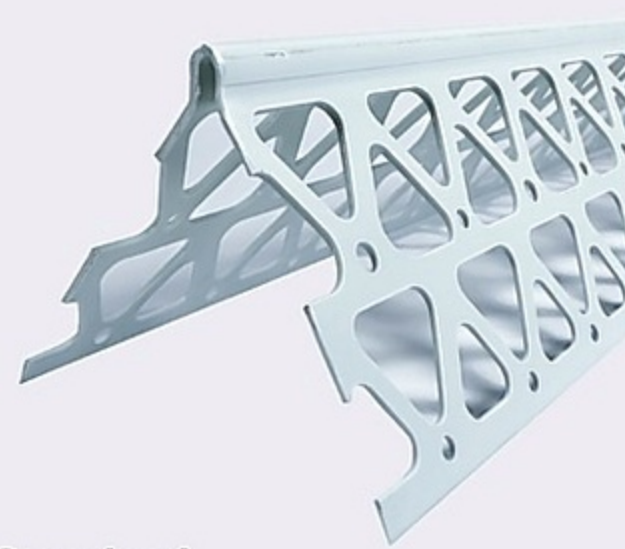

### Standard Corner Beads

Esquinero para paredes de bloques, concreto; para uso interior y exterior

2 1/2" X 2 1/2" X 8'

FDMI170230 **\$73.00** Precio Regular: \$78.00  
BOX 50

2 1/2" X 2 1/2" X 10'

FDMI170130 **\$97.00** Precio Regular  
BOX 50

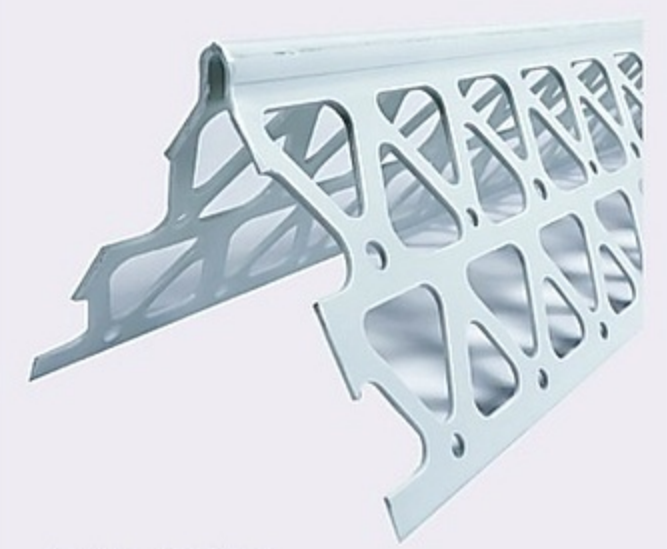

### BULL-BOND. Corner Beads

Esquinero para paredes de bloques, concreto; para uso interior y exterior

2 1/2" X 2 1/2" X 8'

FDBB030230 **\$151.00** Precio Regular: \$156.00  
BOX 100

2 1/2" X 2 1/2" X 10'

FDBB030130 **\$195.00** Precio Regular  
BOX 100

# Terminaciones

BULL-BOND.



**Pro Wall Primer™**  
IMPRIMANTE  
Para paredes

Blanco

**\$110.00** Paila 5gal.

**\$30.00** 1gal.  
Precio Regular

BULL-BOND.



**Pro Dry™**  
PINTURA  
IMPERMEABILIZANTE  
- 3 en 1 pintura | primer | sellador

Blanco

**\$115.00** Paila 5gal.

**\$27.50** 1gal.  
Precio Regular

BULL-BOND.



**Elasto Filler™**  
Masilla Impermeable para  
Grietas e Imperfecciones



Representante de Conspro  
**ERICK RIVERA**

**\$20.50** 1gal. **\$7.00** Qts  
Precio Regular

EVONIK



**Protectosil Chem-Trete 40voc**  
REPELENTE DE AGUA  
Transparente, penetrante y transpirable

Uso: Superficies exteriores sobre nivel del suelo:

- Concreto
- Mampostería de ladrillo
- Unidades de mampostería de concreto
- Algunas piedras naturales

Propiedades:

- Penetra la superficie
- Se une químicamente al sustrato
- Fijación permanente de la molécula repelente de agua
- No es un recubrimiento
- No decolora ni cambia la apariencia de la superficie

**\$218.00**

Pail. 5gal.

Precio Regular

YouTube

Video de Aplicación



**Clear Seal**  
Multi-Usos Penetrante  
Penetrante 100% Acrílico

**\$90.00** Paila 5gal.

**\$25.00** 1gal.  
Precio Regular



PISO DE CONCRETO



TEJAS



Representante de Conspro  
**GUSTAVO J. DELUCCA**

TRAFFIC PAINT

PRO FLOOR  
BLACK

BULL-BOND.



**Pro Grip™**  
Pintura para piso  
texturizada

**\$87.00** Paila 5gal.

**\$21.00** 1gal.  
Precio Regular

Gris Claro  
Gris Oscuro  
Terracota  
Champagne  
Oak  
Verde

**Anti**  
Resbaladizo



BULL-BOND.



**Pro Floor™**  
Pintura para  
pisos con tráfico  
vehicular

**\$92.00** Paila 5gal.

**\$21.50** 1gal.  
Precio Regular

Light Gray

Dark Gray

Black

BULL-BOND.



**Traffic Paint™**  
Pintura de tráfico para  
marcar pavimentos



1gal.

Paila 5gal.

White

**\$22.00**  
Precio Regular

**\$90.00**  
Precio Regular

Blue

**\$22.00**  
Precio Regular

**\$90.00**  
Precio Regular

Yellow

**\$24.00**  
Precio Regular

**\$105.00**  
Precio Regular

HEMPEL  
Trust is earned



**Hempadur Mastic**

Part A 45889 Gray 3.75gal + Part B 95881 1.25gal)

Pintura epoxi de altos sólidos. Ideal para acero y concreto, puede usarse como imprimante, capa intermedia o acabado.

**\$220.00** Kit 5gal.

Precio Regular

HEMPEL  
Trust is earned



**Acrylithane HS4  
Top Coat**

Parte A-B

Recubrimiento superior de poliuretano de alto rendimiento,

**\$160.00** Kit 1.25gal.  
Precio Regular



White  
FDNG073060

Light Gray  
FDNG071760

Black  
FDNG073180

**T Flakes**  
TORGINOL

 Blue Granite <b>Hybrid</b> \$195.00 BOX 40 lb.	 Jawbreaker <b>Hybrid</b> \$195.00 BOX 40 lb.	 Aurora 1/4 \$165.00 BOX 40 lb.	 Comet 1/4 \$165.00 BOX 40 lb.	 Nordic Green 1/4 \$165.00 BOX 40 lb.	 Quail 1/4 \$165.00 BOX 40 lb.	 Thyme 1/4 \$165.00 BOX 40 lb. Pala	 Waxwing 1/4 \$165.00 BOX 40 lb.
--	--	--	--	--	---	--	---

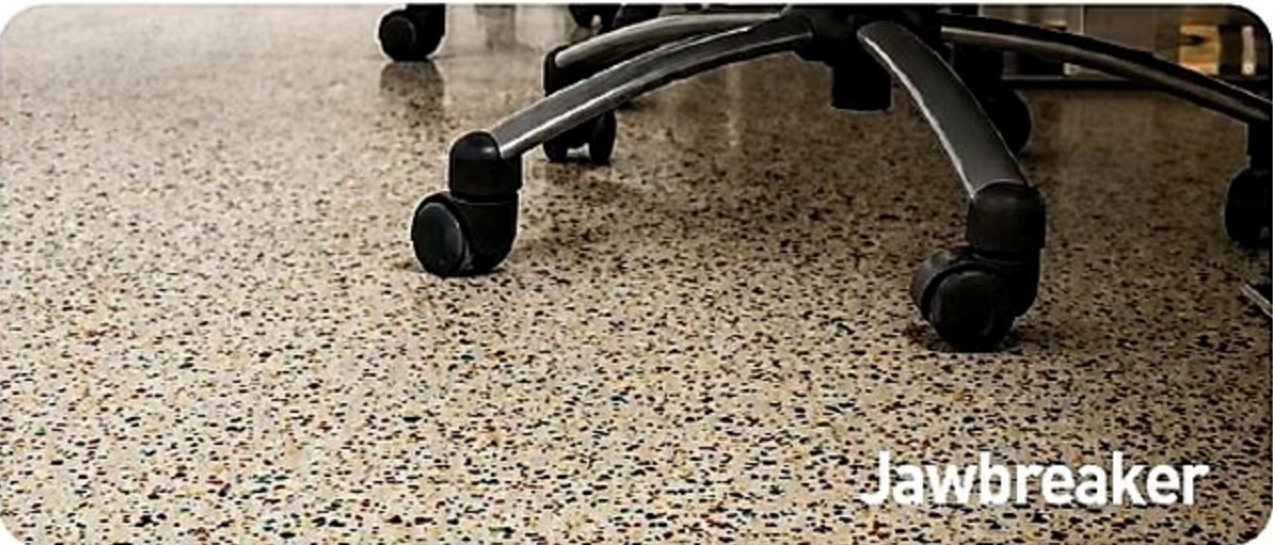

**T Quarzo**  
TORGINOL

 Dalmatian 40-S \$62.00 BOX 50 lb.	 Quicksand 40-S \$62.00 BOX 50 lb.	 Twilight 40-S \$62.00 BOX 50 lb.	 Crystal 40-S \$62.00 BOX 50 lb.	 Plum 40-S \$56.00 BOX 50 lb.	 Ash 40-S \$56.00 BOX 50 lb.	 Lemongrass 40-S \$56.00 BOX 50 lb.	 White 40-S \$56.00 BOX 50 lb.	 Cobalt 40-S \$56.00 BOX 50 lb.
--	---	--	---	---	---	--	---	--

**PREMERA® Pulido y Protección de Concreto**



**PREMERA HLT**  
Barrera química anti humedad permanente  
\$150.00 1gal.

**Matting Agent**  
Aditivo mate para T2/T9  
\$15.00 0.15 lbs

**Non Skid**  
Aditivo Anti-Resbaladizo  
\$23.00 0.52 lbs

**PREMERA T2 MCM**  
Recubrimiento sol-gel protector  
\$170.00 1gal.

**PREMERA Quick Seal**  
Sellador acrílico previo T2  
\$80.00 1gal.

**PREMERA FP1 Fusion Primer**  
Imprimación para concreto  
\$180.00 1gal.

**Sistema de Pulido en Un Día**  
**PREMERA CRYSTAL GUARD**  
Protección química y abrasiva durable  
\$125.00 1gal.

**PREMERA CRYSTAL DENSIFIER**  
Capa barrera cuarzo-polímero  
\$715.00 Pala 5gal. | \$155.00 Pala 1gal.

# Herramientas de Remoción



**Disco de Desgaste Doble Fila**  
5/8 -11# Grano 30  
Para Aplanar y Alisar Concreto

<b>4.5"</b>	<b>7"</b>
FDMI021720	FDMI021320
<b>\$67.00</b>	<b>\$107.00</b>
Precio Regular	Precio Regular



**Disco de Desgaste Turbo**  
5/8 -11# Grano 30  
Para Remover y Escarbar Concreto

<b>5"</b>	<b>7"</b>
FDMI021420	FDM I021520
<b>\$54.00</b>	<b>\$82.00</b>
Precio Regular	Precio Regular



**Raspador**  
54in x 7in  
FDMT043120  
12504

**\$36.75**  
Precio Regular

**Crimped Wire Cup Brush 3"**



FDIV030120  
39041  
**\$6.75**  
Precio Regular



**5"** **\$115.00**  
Precio Regular

**PCD Stonecrete**  
DISCO DE REMOCIÓN  
en techos, pisos y paredes  
Cup Wheel 5/8-11



**7"** **\$155.00**  
Precio Regular



Representante de Conspro  
**EDISON RIVERA**



**Zec**  
DISCO DE REMOCIÓN  
techos, pisos y paredes

**7"**  
**\$12.50**  
FDMI020120  
Granos 12  
Precio Regular

**4.5"**  
**\$9.00**  
FDMI020320  
Granos 16  
Precio Regular



**Disco de Desgaste CONCAVO**

5/8 -11# Grano 40  
Para crear canales y  
cavidades en concreto



Liquidación  
**\$240.00**

\$255.00 Precio Regular



# Limpiadores



**Industrial Degreaser** **\$28.00**  
Degreaser concentrado, alcalino  
no-abrasivo, formulado para la  
limpieza y remoción de grasas  
Pail. 5gal.



**Multi Use Cleaner** **\$23.00**  
limpiador multi-uso remueve  
toda clase de sucio, grasas,  
aceites, carbón.  
Pail. 5gal.



**Dish Washer** **\$37.00**  
Detergente líquido con fragancia  
Su fórmula espesa corta la grasa.  
Biodegradable y no  
contiene fosfatos.  
Pail. 5gal.



**Car Wash & Wax** **\$35.00**  
Detergente líquido para autos, con  
cera. Fórmula espesa remueve grasa,  
sucio y marcas de tráfico.  
Biodegradable y no contiene fosfatos.  
Pail. 5gal.



**Kleankrete**  
ÁCIDO  
-Elimina salpicado de mortero  
luego de trabajar.  
**\$60.00** 4gal.  
Precio Regular



**Acetona**  
FDMI150160  
SOLVENTE  
-Ideal para limpieza  
de concreto previo a aplicación  
de selladores  
**\$118.00**  
Precio Regular  
Pail. 5gal.



**Xylene**  
SOLVENTE  
FDMI150260  
**\$100.00**  
Precio Regular  
Pail. 5gal.



**Swissmex Acetone 5**  
1.5 Litros  
FDMI082520 3101351  
**\$60.00**  
Precio Regular



**Swissmex Acetone 10**  
5 Litros  
FDMI082620 319305  
**\$125.00**  
Precio Regular



**Swissmex Acetone 30**  
9 Litros  
FDMI082720 322310  
**\$145.00**  
Precio Regular



**Palo EVER TOUGH PRO NS**  
6'-12'  
Anodized Aluminum /  
Fiberglass Extension Pole  
FDLI050120  
72144  
**\$36.00**  
Precio Regular

**Gancho**  
PRO BARRACUDA  
ROLLER FRAME  
FDLI061820 RF800

18"  
**Especial \$16.00**  
Precio Regular \$20.75



**Cepillo con Palo**  
24"  
FDMT030920  
16416  
**Liquidación \$27.00**  
\$33.00 Precio Regular



**Llana**  
14" X 4"  
FDMT040220  
12140  
**\$38.75**  
Precio Regular



**Flotin**  
24"  
FDMT044020  
28434  
**\$40.50**  
Precio Regular



**Flotin Cónico**  
FDMT044120  
14615  
30"  
**\$54.75**  
Precio Regular



**Rodilleras**  
FDIV040220  
**\$29.50**  
Precio Regular



**Flap Sun Hat**  
FDMI420220  
**\$19.99**  
Precio Regular



**T-shirts Microfibra UV**  
Variedad de colores  
FDMI401520  
**\$15.99**  
Precio Regular

**Mezclador para 1Quarto**  
FDAL010390  
HMQ



**\$5.25**  
Precio Regular

**Mezclador para 1gal**  
FDLI040220  
M101  
**\$4.75**  
Precio Regular



**Rueda de Medir 4"**  
FDUL010120  
H-3756  
**\$44.00**  
Precio Regular



Representante de Conspro  
**ERICK RIVERA**



**ALBAÑILERÍA  
REPARACIÓN DE CONCRETO  
IMPERMEABILIZACIÓN  
TERMINACIONES**

**Departamento de Contratista**



**Gustavo J. Delucca**  
(787) 903-1914  
gdelucca@conspiro.com



**Fermin Fontáñez**  
(787) 510-7196  
fermin@conspiro.com



**Edison Rivera**  
(787) 944-4912  
erivera@conspiro.com



**Erick Rivera**  
(787) 529-9727  
erickrr@conspiro.com



**Luis Fernandez**  
(787) 436-8818  
lfernandez@conspiro.com



**Eric Rivera Zayas**  
(787) 310-2865  
eriveraz@conspiro.com

**San Juan**

Lunes a Viernes  
Horario: 7:00am a 4:00pm  
Tienda: (787) 653-4907  
 (787) 903-1416

sanjuan@conspiro.com  
Ave Campo Rico #904 Urb. Country Club  
San Juan Puerto Rico 00927



**Caguas**

Lunes a Viernes  
Horario: 7:00am a 3:00pm  
Tienda: (787) 653-4900  
 (787) 381-3491

caguas@conspiro.com  
Road PR-175 Km 0.2 Rio Cañas  
Ind. Park Lot #35 Caguas PR 00725



**Entrega Gratis**

Plazo de entrega 4-7 días.  
Entrega Puerta a Puerta



**Asistencia Técnica  
Personalizada**

**(787) 653-4900**

**conspiro.com**